

# BAKER'S SELECT

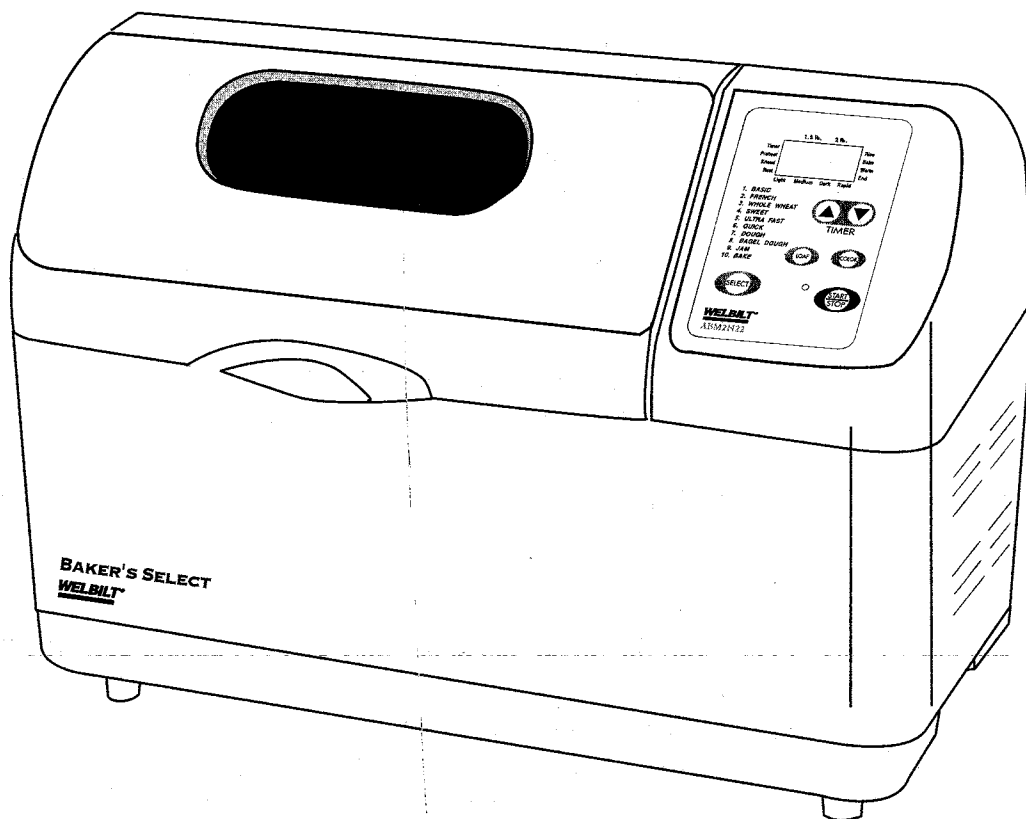

**MODEL ABM2H22**

## INSTRUCTION MANUAL

**WELBILT®**

**HOUSEHOLD USE ONLY**

# IMPORTANT SAFEGUARDS

---

WHEN USING ELECTRICAL APPLIANCES, BASIC SAFETY PRECAUTIONS SHOULD ALWAYS BE FOLLOWED, INCLUDING THE FOLLOWING:

1. Read all instructions carefully.
2. Do not touch hot surfaces. Use handles or knobs and a potholder. Do not close or clog the steam vent openings under any circumstances.
3. To protect against electrical shock, do not immerse cord, plug, or any other part of this bread machine, in water or other liquid.
4. Close supervision is necessary when any appliance is used by or near children.
5. Unplug the power supply cord when the appliance is not in use, or before cleaning. Allow to cool before putting on or taking off any parts.
6. Do not use or operate the appliance with a damaged cord or plug, or after the appliance malfunctions or has been damaged in any manner. Return appliance to the nearest authorized service facility for examination, repair or adjustment.
7. The use of accessory attachments not recommended or sold by the manufacturer may cause injuries.
8. Do not use outdoors.
9. Do not let the power supply cord hang over the edge of table or counter, or touch hot surfaces.
10. Do not place the appliance on or near hot gas or electric burners, or in a heated oven.
11. Extreme caution must be used when moving an appliance containing hot contents or liquids.
12. To disconnect, press STOP, then remove plug from wall outlet. Grip plug and pull from wall outlet. Never pull on the cord.
13. Do not use the bread machine for other than intended use.
14. Avoid contact with moving parts during operation.
15. Do not pour any ingredients directly into the bread machine - only into the baking pan. The baking pan must then be placed in the machine.
16. Do not operate this appliance in the presence of explosive and/or flammable fumes.
17. This appliance is intended for HOUSEHOLD USE ONLY and not for commercial or industrial use.
18. To avoid damaging the machine, do not place the baking pan or any object on top of the unit.
19. Do not clean with scouring pads. Pieces can break off the pad and touch electrical parts, creating a risk of electric shock.
20. Do not use bread machine for storage purposes nor insert any utensils, as they may create a fire or electric shock.

## SAVE THESE INSTRUCTIONS

This appliance has a polarized plug (one blade is wider than the other). As a safety feature, this plug will fit in a polarized outlet only one way. If the plug does not fit fully in the outlet, reverse the plug. If it still does not fit, contact a qualified electrician. **DO NOT ATTEMPT TO DEFEAT THIS SAFETY FEATURE.**

A short power-supply cord is provided to reduce the risk of becoming entangled in or tripping over a longer cord. An extension cord may be used if precautions are taken in their use. If an extension cord is used:

1. The marked electrical rating of the extension cord should be at least as great as the electrical rating of the appliance.
2. The cord should be arranged so that it will not drape over the countertop or tabletop where it can be pulled on by children or tripped over accidentally.

## About Your Bread Machine

---

- The bread machine makes LARGE (1 1/2 lb.) and EXTRA LARGE (2 lb.) horizontal loaves of breads.
- Two-paddle horizontal bread pan makes traditional shaped bread.
- The bread machine has 33 settings. See *Bread Machine Cycle Times*, page 15.
- Special ULTRA FAST setting allows you to complete the breadmaking process in 58 minutes. Special recipes must be used for these cycles.
- The Fruit and Nut Beep signals when it is time to add ingredients such as fruits, nuts, or chips. It will maintain ingredients' shape and texture rather than be chopped up by the kneading blade. If you use the TIMER to delay baking, you may add all the ingredients at once and bypass the function. However, the fruits, nuts, or chips may get somewhat chopped.
- RAPID settings for BASIC, FRENCH, and WHOLE WHEAT breads allow you to make standard recipes in a shorter period of time. Choose the RAPID setting by pressing the COLOR key.
- The crust color of your fresh homemade bread can be controlled for personal preference.
- 13-HOUR PROGRAMMABLE TIMER lets you wake up to hot baked bread in the morning.
- Large VIEWING WINDOW allows you to watch the breadmaking process.
- The KEEP WARM function prevents the bread from getting soggy by keeping finished bread warm up to an hour after the baking is completed. This function stops when the unit is turned OFF/STOP or is unplugged.
- The bread machine is designed with a cool-touch exterior.
- The bread machine has POWER LOSS MEMORY, which resumes cycle where it left off when a short-term power loss occurs.
- Do not cover the bread machine with towels or other materials that may prevent steam from escaping. Some steaming from vents is normal.
- Do not place any objects on top of the bread machine.
- Unplug the unit and wait until it cools, then remove any spilled ingredients or crumbs from the baking chamber of the bread machine by wiping with a damp sponge or cloth. See *Care and Cleaning*, page 14.

**IMPORTANT:** Always add ingredients in the order they are specified in the recipe. For best results, **accurate measuring of ingredients is vital.** Do not put larger quantities than recommended into the baking pan as it may produce poor results and may damage the bread machine.

**To clear a program after you have started it, push the "START/STOP" button until you hear a beep. Zeroes will appear in the display window and you can now enter another program.**

# Before Your First Use

Enjoy using your Welbilt® Bread Machine. Before your first use, please take a few minutes to read this Instruction Manual and keep it handy for reference. Please pay particular attention to the safety instructions we have provided for your protection.

Carefully unpack the bread machine and remove all packaging materials. To remove any dust that may have accumulated during packing, wipe the baking pan, kneading blade and outside surface of the bread machine with a clean, damp cloth. **Do not use scouring pads or any abrasives on any part of the bread machine.**

Plug the cord into a 120-volt AC outlet. The cord length of this bread machine was selected to reduce the possibility of tangling or tripping over a longer cord. If more cord length is needed, use a UL certified extension cord rated no less than 15 amperes and 120 volts. The longer cord should be arranged so that it will not drape over the countertop where it can be pulled on by children or tripped over.

## TABLE OF CONTENTS

### OPERATING INSTRUCTION SECTION

Important Safeguards	2
About Your Bread Machine	3
Before Your First Use	4
Know Your Bread Machine	5
Control Panel	6
Setting Descriptions	7-8
Using Your Bread Machine	9-12
Using the Timer	13
Slicing and Storing Bread	13
Care and Cleaning	14
Bread Machine Cycle Times	15
Know Your Ingredients	16-18
Measuring Your Ingredients	19
Recipe Tips	20

### RECIPE SECTION

White Bread	21
Ultra Fast White Bread	21
Rye Bread	21
Onion Bread	22
Egg Bread	22
Ultra Fast Egg Bread	22
Honey Oats Bread	23
Pesto Bread	23
Ultra Fast Pesto Bread	23
Cheve-Cracked Pepper Bread	24
Ultra Fast Cheve-Cracked Pepper Bread	24
French Bread	25
100% Whole Wheat Bread	25
Triple Wheat Bread	25
Pumpernickel Bread	26
Shredded Wheat Bread	26
Cranberry Walnut	27

Rich Sweet Bread	27
Holiday Bread	28
Cinnamon Raisin Bread	28
About Quick Breads	29
Apple Walnut Loaf	30
Banana Nut Bread	30
Irish Soda Bread	30
Corn Bread	31
Cinnamon Rolls	31
Pizza Crust	32
Dinner Rolls	32
Danish Pastries	33
Soft Pretzel	34
Bread Sticks	35
Hand Shaped French Bread	35
Bagels	36
Egg Bagels	37
Sun Dried Tomato Bagels	37
Strawberry Preserves	38
Low Sugar Strawberry Jam	38
About Gluten-Free Breads	39
Gluten-Free Potato Bread	40
Gluten-Free Cinnamon Raisin Bread	40
Gluten-Free Mock Light Rye	41
Gluten-Free Brown & White Rice Bread	41
Gluten-Free Cheddar Loaf	42
Gluten-Free Romano Bean Bread	43
Gluten-Free Cardamom Fruit Bread	44
<b>HELP SECTION</b>	
Troubleshooting	45
Questions & Answers	46-48
Baking Tips For Yeast Breads	49
Limited Warranty	51

# Know Your Bread Machine

**ABM2H22 MAKES 1 1/2 AND 2 LB. HORIZONTAL LOAVES**

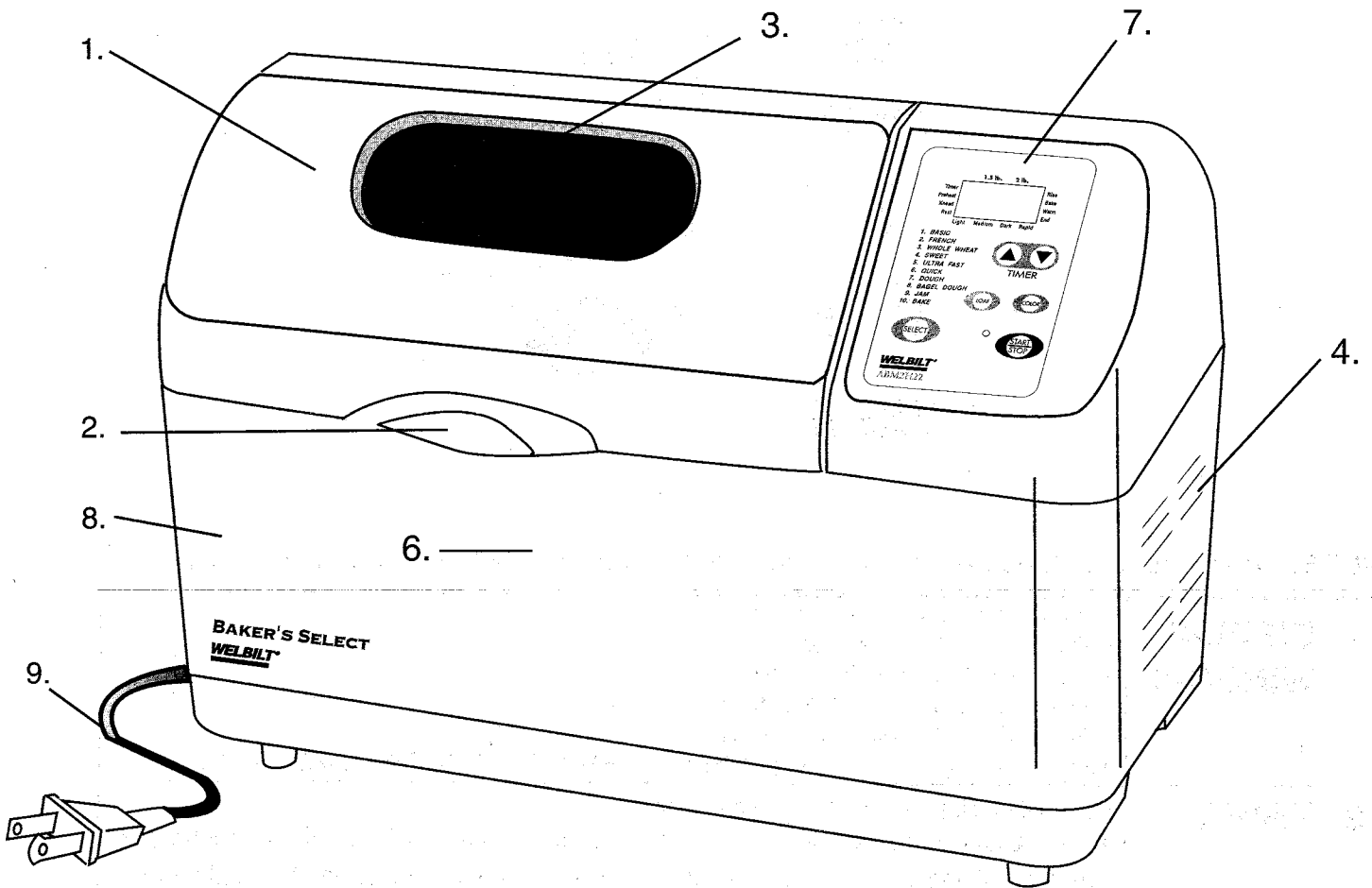

1. Lid
2. Lid Handle
3. Large Viewing Window
4. Air Vents
5. Bread pan
6. Baking Chamber (not shown)
7. Control Panel
8. Cool-Touch Body
9. Power Cord with Plug
10. Drive Shafts
11. Kneading Blades
12. Bread Pan Handle

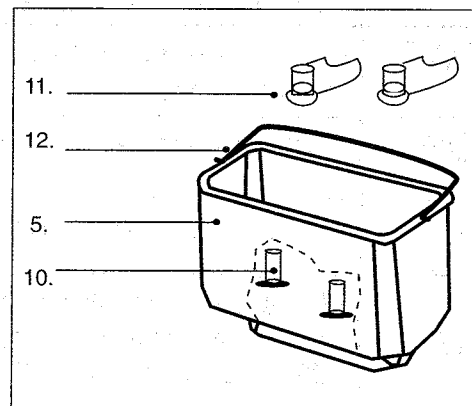

# Control Panel

Model ABM2H22

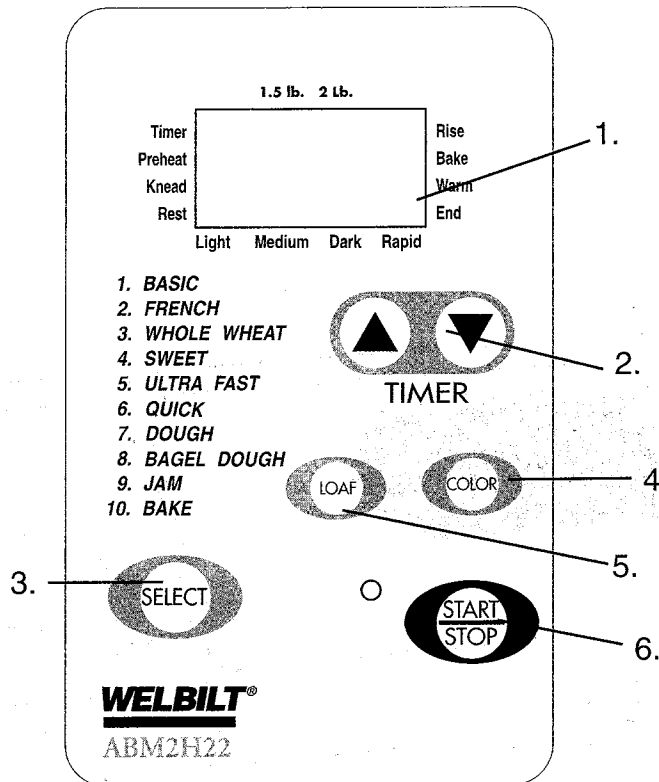

**NOTE:** When using the touchpad controls, be sure to press the pad until you hear a beep.

<p><b>1 DISPLAY WINDOW</b></p>	<ul style="list-style-type: none"> <li>• Shows the SELECT number selected.</li> <li>• Shows the LOAF size selected.</li> <li>• Shows the CRUST COLOR selected.</li> <li>• Shows minute-by-minute baking time countdown.</li> <li>• Shows DELAY BAKING TIME selected.</li> <li>• Shows the stage of breadmaking (TIMER, PREHEAT, KNEAD, REST, RISE, BAKE, WARM, END).</li> </ul>
<p><b>2 TIMER</b></p>	<ul style="list-style-type: none"> <li>• Use when setting the TIMER to delay baking.</li> <li>• Press ▲ and ▼ arrows to set timer for delayed completion up to 12 hours and 58 minutes later.</li> <li>• Arrows will move time up or down in 10-minute increments. Press and hold button for faster movement. TIMER is not available on some cycles, please check the <i>Bread Machine Cycle Times</i>, page 15.</li> </ul>
<p><b>3 SELECT</b></p>	<ul style="list-style-type: none"> <li>• Press to select the baking cycle of your choice. The selected cycle automatically assigns the time needed to complete the process.</li> </ul>
<p><b>4 COLOR</b></p>	<ul style="list-style-type: none"> <li>• Press to select the crust color.</li> </ul>
<p><b>5 LOAF</b></p>	<ul style="list-style-type: none"> <li>• Press to select the loaf size: LARGE (1 1/2 lb.) or EXTRA LARGE (2 lb.).</li> </ul>
<p><b>6 START/STOP</b></p>	<ul style="list-style-type: none"> <li>• Press to start operation or begin TIMER countdown for delayed completion.</li> <li>• Press and hold until you hear a beep to stop operation or to cancel a TIMER setting.</li> </ul> <p><b>NOTE:</b> Do not press "STOP" when checking the progress of bread.</p>

# Setting Descriptions

---

Follow this flow chart to make bread as easy as 1,2,3.



1. Press SELECT key to select the desired baking cycle.
2. Press COLOR key to select the crust color preferred.
3. Press LOAF key to select the desired bread size.
4. Press TIMER key to have bread machine bake up to 12 hours and 58 minutes in advance.
5. Press START key to begin baking.

## **BASIC BREADS**

The settings are used for breads that primarily use white flour, although some recipes may include small amounts of whole wheat flour. The settings have the minimum number of rising cycles and the shortest overall times until baking is completed. Therefore, loaves will be slightly denser than French or Sweet breads. Select from BASIC settings, according to loaf size and crust color.

## **FRENCH**

Traditionally, French bread has a crispier crust and lighter texture than basic breads. Recipes usually do not include butter, margarine, or milk.

## **WHOLE WHEAT/ MULTI-GRAIN**

The settings are used for recipes with significant amounts of whole wheat or rye flour, oats, or bran. It begins with a rest period during which the flours or grains absorb the liquid ingredients. Soaking causes the flour or grain to soften and helps ingredients to combine well. The settings have an extra rise cycle to allow heavy wheat and grains to expand. Generally, whole wheat and multi-grain breads are shorter and denser than basic, French, or sweet breads. Select from WHOLE WHEAT settings.

## **SWEET**

Use this setting for recipes that use fruit juice, additional sugar, or added sweet ingredients such as coconut flakes, raisins, dried fruit, or chocolate. Baking temperature is reduced to prevent burning and the extra rise cycle gives the loaves a light, airy texture.

## **ULTRA FAST**

This setting is designed to make bread in only 58 minutes. Only specially designed recipes are appropriate for this setting. These recipes call for very warm water and a large amount of bread machine or fast rising yeast. Heavy flours and other heavy ingredients are not suitable for this setting.

## **QUICK BREAD / CAKE**

This setting is used for recipes that contain baking powder or baking soda rather than yeast to make bread or cake rise. Cake recipes must be specially designed for this setting.

## **DOUGH**

This setting only makes dough and will not bake the final bread. Remove the dough and shape it to make pizza, rolls, pretzels, doughnuts, and round or braided breads. Then bake in a conventional oven or fry in a deep fryer (i.e. doughnuts).

## **BAGEL DOUGH**

This setting is a special dough setting for bagels only and will not bake the final bread. Remove the dough and follow the recipe for making bagels.

## **JAM**

Use this setting for making jam from fresh fruits. Do not double recipes or allow ingredients to boil over the pan into the baking chamber. Should this happen, stop the machine immediately. Allow to cool and clean thoroughly.

## **BAKE**

This is a bake-only setting that does not mix. If you have baked a loaf of bread in your machine and would prefer a darker crust, use the BAKE setting to bake the loaf for a longer period of time. Set the machine to the BAKE setting and press the START key. Watch your time and stop the machine when desired. The bake cycle is preset for 60 minutes. This setting is especially helpful when making gluten-free breads (see page 39).





# Using Your Bread Machine

These are instructions for bread baking only—not dough, jam or bake cycles. The bread settings in this unit will combine ingredients, knead, and make bread from start to finish automatically. The DOUGH setting makes dough for a variety of recipes that can be shaped and baked in an oven. To delay completion, the automatic TIMER may be programmed to make bread or dough while you are at work or asleep. See *Using The Timer*, page 13.

The recipes included with this booklet have been thoroughly tested to ensure best results. Recipes have been created by home economists specifically for these bread machines and may not produce acceptable results in other similar bread machines.

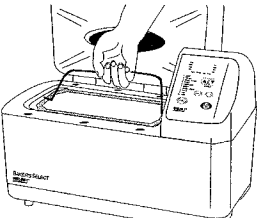
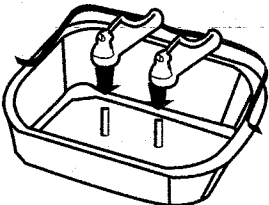
## FOR ALL BREAD BAKING SETTINGS, FOLLOW THESE INSTRUCTIONS:

<p><b>1</b></p>	<p>Open the lid and remove the baking pan by pulling slightly forward on the handle, then up and out. It is important to remove the baking pan from the unit when putting ingredients into the pan. This will prevent accidentally spilling ingredients into the baking chamber.</p> 	<p><b>WARNING:</b></p> <ul style="list-style-type: none"> <li>Place your bread machine where it is level, stable, and secure.</li> <li>Ingredients spilled in baking chamber can cause fire when ignited by the heating element.</li> </ul>
<p><b>2</b></p>	<p>Attach the kneading blades onto the shafts inside the baking pan by lining up the flat side of the blade with the flat side on the shaft. Push the blades firmly onto the shafts.</p> 	<ul style="list-style-type: none"> <li>Be sure to set the kneading blades firmly in place to prevent blades from coming off during operation, which may affect the kneading or mixing.</li> <li>Be sure the shafts are clean of any residue (i.e. dough). This will ensure the kneading blades will fully fit into place and will prevent blades from sticking to shafts.</li> </ul>
<p><b>3</b></p>	<p>Select a recipe from the recipe section of this booklet. When following the recipes:  <b>Measure ingredients carefully and accurately.</b> To measure liquids, use a see-through liquid measuring cup and check the measurement at eye level. When measuring dry ingredients, use a standard dry measuring cup and level the ingredients with a straightedge knife. <b>Slightly inaccurate measurement can make a difference in results.</b> Use standard measuring spoons and level off with a straightedge knife.          See <i>Measuring Your Ingredients</i>, page 19.</p> <ul style="list-style-type: none"> <li>Always add ingredients into the baking pan in the order listed.</li> <li>Always add yeast last. Be sure the yeast does not touch the liquid ingredients.</li> </ul> 	<ul style="list-style-type: none"> <li>Be careful not to mix the yeast with any of the wet ingredients, especially when using the delayed timer feature. Otherwise, the bread may not rise properly.</li> </ul> <p><b>Breadmaking Tip:</b>          After 5 minutes of kneading, open the lid of the bread machine and check the dough consistency. The dough should form a soft, tacky ball. If too dry, add liquid. If too wet, add flour.</p> <p><b>Note:</b>          Additional liquid or flour should be added in 1/2- 1 TBSP. increments.</p>

# Using Your Bread Machine

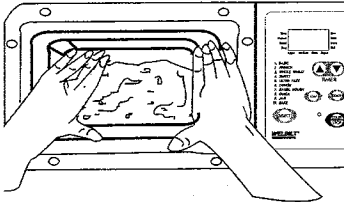
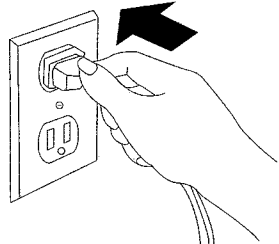
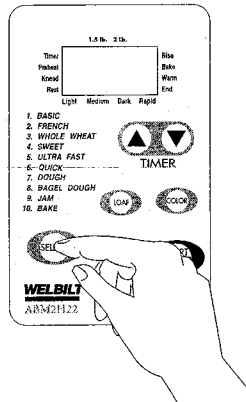
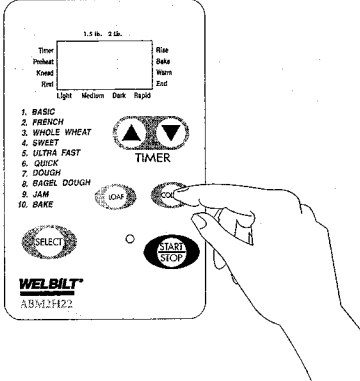
<p><b>4</b></p>	<p>Place the baking pan back into the unit in a slightly forward, angled position. Push down and back on the pan until you hear it click firmly into place. Fold the handle down.</p> 	<p><b>Special Note:</b> If the baking pan is not installed properly or firmly clicked into place, the kneading blades will not operate.</p>
<p><b>5</b></p>	<p>Close the lid. Connect the plug to a 120-volt AC-only outlet. You will hear a beep and the display will be blank.</p> 	<p><b>Caution:</b> This appliance has a polarized plug (one blade is wider than the other). As a safety feature, this plug will fit in a polarized outlet only one way. If the plug does not fit fully in the outlet, reverse the plug. If it still does not fit, contact a qualified electrician. Do not attempt to defeat this safety feature.</p>
<p><b>6</b></p>	<p>Choose the correct setting for your recipe by pressing the SELECT button. Each time SELECT is pressed, you will hear a beep and the number in the display window will advance to the next cycle.</p> 	<p><b>Special Note:</b> The Whole Wheat settings begin with a rest period during which the flours or grains absorb the liquid ingredients. Soaking causes the flour or grain to soften and helps ingredients to combine well. There is no blade action during this period.</p>
<p><b>7</b></p>	<p>Press the COLOR button to choose crust color desired. There are three choices: Light, Medium, or Dark. When you press the button, you will hear a beep, and the display window will show the color selected. You can also choose RAPID cycle by pressing COLOR key.</p> 	<p><b>Note:</b> Select crust color only for Basic, French, and Whole Wheat settings.</p>

# Using Your Bread Machine

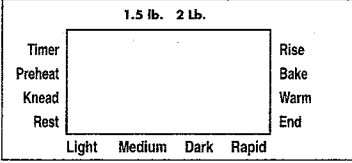
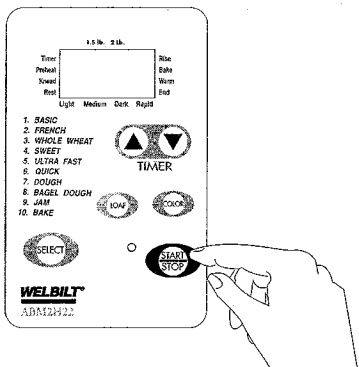
<p><b>8</b></p>	<p>Press the LOAF button to choose the desired loaf size . When you press the button, you will hear a beep, and the display window will show the size of the loaf selected.</p> 	<p><b>Note:</b> Select Loaf Size only for French, Basic, Whole Wheat, Sweet, and Ultra Fast settings.</p>
<p><b>9</b></p>	<p>Press the TIMER button to delay the completion of your bread for up to 13 hours. For details see the <i>Using The Timer</i>, page 13.</p>	<p><b>Special Note:</b> For some cycles, there is no timer setting. See <i>Bread Machine Cycle Times</i>, page 15.</p>
<p><b>10</b></p>	<p>Press the START/STOP button to begin. The remaining time will count down in one-minute increments. When the baking time is completed, a beep will sound five times.</p> <p>To cancel a program once you have started it, press the START/STOP button again until you hear a beep. You can now reprogram the machine.</p> 	<p><b>Breadmaking Tip:</b> After 5 minutes of kneading, open the lid of the bread machine and check the dough consistency. The dough should form a soft, tacky ball. If too dry, add liquid. If too wet, add flour.</p> <p><b>Note:</b> Additional liquid or flour should be added in 1/2 -1 TBSP. increments.</p>
<p><b>11</b></p>	<p>The bread machine is designed with a Keep Warm feature that automatically begins when the bake time is completed. This will continue for up to 60 minutes after baking is complete. During this time, the bread machine will circulate hot air to keep the bread warm and there will be 5 beeps every 5 minutes. You may remove the baking pan at any time during the Keep Warm cycle. To turn off the Keep Warm feature before the 60 minutes are up, simply press the STOP button and hold it until you hear a beep. <b>UNPLUG THE UNIT WHEN FINISHED.</b> Never leave the unit plugged in when not in use.</p>	<p><b>Note:</b> The Keep Warm feature does not function on some cycles. See <i>Bread Machine Cycle Times</i>, page 15.</p>

# Using Your Bread Machine

**12**

The bread machine has a convenient viewing window so that you may watch the progress of the bread as it is mixed, kneaded, and baked. Occasionally, some moisture may form in the window during baking. You may lift the lid to look inside during mixing and kneading stages. However, **DO NOT OPEN THE LID DURING THE BAKING CYCLE**, (approximately the last hour) as this may cause the bread to collapse.

**Warning:**

To avoid damaging the bread machine, do not put any object on top of the unit.

**13**

To remove the bread from the baking pan, **use pot holders or oven mitts** and pull slightly forward on the handle, then up and out. Turn the pan upside down and shake the bread out onto a wire cooling rack. The baking pan has a non-stick finish so the bread should come out easily. Do not use metal utensils to remove bread as they may scratch the non-stick surface. If you have difficulty removing bread from the baking pan, slide a flat rubber or plastic spatula along the sides of the pan to loosen the loaf. Turn the pan over and shake the loaf out.

Allow the bread to cool before slicing. See *Slicing and Storing Bread*, page 13. If the kneading blade remains in the bottom of the baking pan, fill the baking pan with hot water to loosen. If the kneading blade remains in the bottom of the bread, use the end of a plastic spoon or other non-metal utensil to remove. Do not use a knife or any other sharp metal object as it will scratch the non-stick coating on the kneading blade.

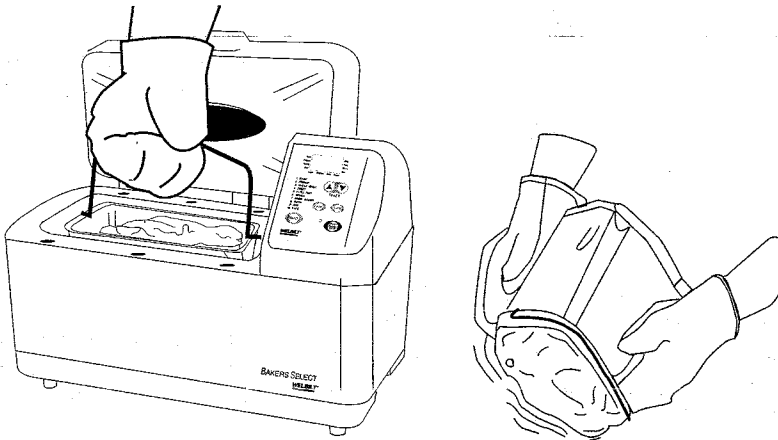

**Note:**

Always check to see where the kneading blade is when removing a baked loaf of bread. If it remains stuck in the bread, you may damage it by cutting into it while slicing.

Occasionally the kneading blade may become stuck in the bread.

**There is nothing wrong with your bread machine.** Simply use a fork and pry the blade out of the bread.

**Important:**

Place warm water in pan immediately after removing bread to prevent blades from sticking to shaft.

**14**

If the temperature in the bread chamber is higher than 122° F, the DISPLAY WINDOW will show "E01". If the temperature is lower than 14° F, the DISPLAY WINDOW will show "E00".

**Warning:**

If "E01" error message appears, do not make another loaf until the bread machine cools down. If "E00" error message appears, allow the machine to warm up above 14° F.

## Using The Timer

### TO SET THE TIMER, FOLLOW THESE INSTRUCTIONS:

	<p>First, follow steps 1 thru 8 in <i>Using Your Bread Machine</i>, pages 9-11.</p> <p><b>Note: The maximum length of delay is up to 12 hours and 58 minutes, depending on the selected setting.</b></p> <p><b>Note:</b> Do not use the TIMER with recipes that call for perishable ingredients, such as eggs, fresh milk, sour cream, or cheese.</p>
<b>1</b>	<p>To set the TIMER, press and hold the ▲ arrow on the control panel until the display shows the total program time. If you pass the desired time, simply press ▼ to go back.</p> <p><b>Note:</b> You do not need to mathematically calculate the difference between the setting time and the total hours you want. The machine will automatically adjust to include the setting time. Simply set the TIMER for your total hours.</p>
<b>2</b>	<p>Once you have set the time, press START. The colon (:) in the display will flash to indicate that the TIMER has been set, and the countdown will begin. The TIMER will count down in one-minute increments. When the display reaches 0:00, the bread is complete and the beeper will sound.</p>

For example, it is 8 p.m. now. You want to wake up to a 2 lb. loaf of basic white bread at 8 a.m. The total time between 8 p.m. and 8 a.m. is 12 hours.

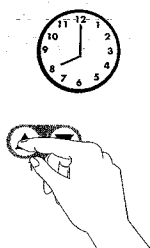

Press and hold the ▲ arrow on the control panel until the display shows 12:00. Press START.

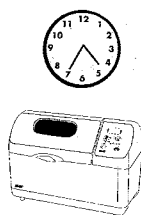

The machine will automatically start making bread at 4:35 a.m.

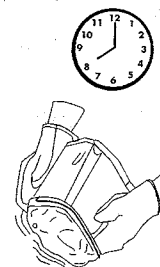

A fresh-baked loaf of bread is ready to serve at 8:00 a.m.

## SLICING AND STORING BREAD

For best results, place bread on a wire rack and allow it to cool 15 to 30 minutes before slicing. Use an electric knife for even slices or use a sharp serrated knife. For square slices, place the loaf on its side and slice across.

Store unused bread tightly covered (reclosable plastic bags or plastic containers work well) at room temperature for up to three days. For longer storage (up to one month), place bread in a tightly covered container in the freezer. Since homemade bread has no preservatives, it tends to dry out and become stale faster than commercially-made bread.

Leftover slightly hardened bread may be cut into 1/2-inch or 1-inch cubes and used in recipes to make croutons, bread pudding, or stuffing.

## Care and Cleaning

### CAUTION:

To prevent electrical shock, unplug the unit before cleaning. Allow the bread machine to cool before cleaning. Do not immerse or splash either the body or lid in any liquid as this may cause damage and/or electric shock.

**For best performance and maintenance, clean the bread machine after each use as follows:**

#### Outer Body, Lid, and Baking Chamber:

Wipe the lid and outer body of the unit with a damp cloth or slightly damp sponge. Use a damp sponge or cloth to wipe out any flour, crumbs, or other materials from the baking chamber. Dry thoroughly.

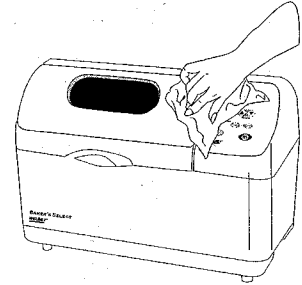

#### Baking Pan and Kneading Blades:

Both the baking pan and kneading blades have non-stick surfaces. Do not use any harsh cleansers, abrasive materials, or utensils that may scratch the surfaces. Over time, the non-stick surface may change in appearance due to moisture and steam. This is normal and has no effect on its use or quality.



Remove the baking pan and kneading blades from the baking chamber before cleaning. Wipe the outside of the baking pan with a damp cloth. **NEVER IMMERSE THE BAKING PAN** in water or other liquid. Wash the inside of the baking pan with warm, soapy water. If the kneading blades get stuck, fill the baking pan with hot water and soak for 30 minutes or until they loosen and can be removed easily. If the hole in the kneading blades become clogged, carefully clean it out with a wooden or plastic toothpick. **Use care to avoid toothpick scratching blade surface or getting stuck in blades.**

**Never use any of the following to clean your bread machine:**

- Paint Thinner
- Benzine
- Steel Wool Pads
- Polishing Powder
- Chemical Dustcloth

**CAUTION:** DO NOT place any part or parts of the bread machine in the dishwasher.

### STORING THE UNIT

Be sure to dry all parts before storing including the viewing window. Close the lid, and do not store anything on top of the bread machine.

### TROUBLESHOOTING

Specific questions about the bread machine functions and problems with ingredients or recipes are addressed in the *Questions and Answers* section on pages 46-48. For better performance, allow the unit to cool completely before beginning to bake a second loaf of bread. You can speed cooling by opening the lid, removing the baking pan, and allowing the baking chamber to cool.

# Bread Machine Cycle Times

MENU	COLOR	LOAF	Total Time	Rest	Knead 1	Rest	Knead 2	Rise 1	Punch	Rise 2	Shape	Rise 3	Baking	Keep Warm	Fruit & Nuts	Setting
BASIC	Light	1.5 LB.	3:18		5m		20m	39m	10s	25m50s	15s	49m45s	53m	1 Hr.	2:59	1
		2 LB.	3:25		5m		20m	39m	10s	25m50s	15s	49m45s	60m	1 Hr.	3:08	2
	Medium	1.5 LB.	3:18		5m		20m	39m	10s	25m50s	15s	49m45s	53m	1 Hr.	2:59	3
		2 LB.	3:25		5m		20m	39m	10s	25m50s	15s	49m45s	60m	1 Hr.	3:08	4
	Dark	1.5 LB.	3:18		5m		20m	39m	10s	25m50s	15s	49m45s	53m	1 Hr.	2:59	5
		2 LB.	3:25		5m		20m	39m	10s	25m50s	15s	49m45s	60m	1 Hr.	3:08	6
	Rapid	1.5 LB.	2:17		5m		20m	15m	10s	8m50s	10s	29m50s	53m	1 Hr.	1:59	7
		2 LB.	2:24		5m		20m	15m	10s	8m50s	10s	29m50s	60m	1 Hr.	2:07	8
	Light	1.5 LB.	3:32		5m		20m	39m	10s	30m50s	10s	59m50s	52m	1 Hr.	N/A	9
		2 LB.	3:35		5m		20m	39m	10s	30m50s	10s	59m50s	55m	1 Hr.	N/A	10
FRENCH	Medium	1.5 LB.	3:32		5m		20m	39m	10s	30m50s	10s	59m50s	52m	1 Hr.	N/A	11
		2 LB.	3:35		5m		20m	39m	10s	30m50s	10s	59m50s	55m	1 Hr.	N/A	12
	Dark	1.5 LB.	3:32		5m		20m	39m	10s	30m50s	10s	59m50s	52m	1 Hr.	N/A	13
		2 LB.	3:35		5m		20m	39m	10s	30m50s	10s	59m50s	55m	1 Hr.	N/A	14
	Rapid	1.5 LB.	2:32		5m		20m	15m	10s	15m50s	10s	38m50s	52m	1 Hr.	N/A	15
		2 LB.	2:35		5m		20m	15m	10s	15m50s	10s	38m50s	55m	1 Hr.	N/A	16
	Light	1.5 LB.	3:45	30m	5m		15m	49m	10s	25m50s	10s	44m50s	50m	1 Hr.	3:00	17
		2 LB.	3:48	30m	5m		15m	49m	10s	25m50s	10s	44m50s	53m	1 Hr.	3:03	18
	Medium	1.5 LB.	3:45	30m	5m		15m	49m	10s	25m50s	10s	44m50s	50m	1 Hr.	3:00	19
		2 LB.	3:48	30m	5m		15m	49m	10s	25m50s	10s	44m50s	53m	1 Hr.	3:03	20
WHOLE WHEAT	Dark	1.5 LB.	3:45	30m	5m		15m	49m	10s	25m50s	10s	44m50s	50m	1 Hr.	3:00	21
		2 LB.	3:48	30m	5m		15m	49m	10s	25m50s	10s	44m50s	53m	1 Hr.	3:03	22
	Rapid	1.5 LB.	2:30	5m	5m		15m	24m	10s	10m50s	10s	34m50s	50m	1 Hr.	2:10	23
		2 LB.	2:33	5m	5m		15m	24m	10s	10m50s	10s	34m50s	53m	1 Hr.	2:13	24
	Medium	1.5 LB.	3:22		5m		20m	39m	10s	25m50s	5s	51m55s	55m	1 Hr.	3:05	25
		2 LB.	3:27		5m		20m	39m	10s	25m50s	5s	51m55s	60m	1 Hr.	3:10	26
	Light	1.5 LB.	0:58		13m							10m	35m	1 Hr.	N/A	27
		2 LB.	0:58		10m							8m	40m	1 Hr.	N/A	28
	QUICK		1:43		3m		5m						90m	1 Hr.	N/A	29
	DOUGH		1:30		5m		20m		60m					N/A	1:12	30
BAGEL DOUGH		2:00		29m				90m	60s					N/A	1:50	31
	JAM	1:05		15m									50m	N/A	N/A	32
	BAKE	1:00											60m	1 Hr.	N/A	33

m = Minute; s = Second; 3:18 = 3 hours, 18 minutes

Note 1: Setting 1, Setting 3, and Setting 5 have the same cycle time, but result in different crust colors.

Note 2: Fruits and Nuts column shows time on display when ingredients are to be added.

Note 3: Delay TIMER is not available on Ultra Fast, Quick, Jam, and Bake settings.